



# 110V MAGNETIC DRILLING MACHINE 35MM

MODEL NO: **MAG110V**

Thank you for purchasing a Sealey product. Manufactured to a high standard, this product will, if used according to these instructions, and properly maintained, give you years of trouble free performance.

**IMPORTANT:** PLEASE READ THESE INSTRUCTIONS CAREFULLY. NOTE THE SAFE OPERATIONAL REQUIREMENTS, WARNINGS & CAUTIONS. USE THE PRODUCT CORRECTLY AND WITH CARE FOR THE PURPOSE FOR WHICH IT IS INTENDED. FAILURE TO DO SO MAY CAUSE DAMAGE AND/OR PERSONAL INJURY AND WILL INVALIDATE THE WARRANTY. KEEP THESE INSTRUCTIONS SAFE FOR FUTURE USE.



Refer to instruction manual



Wear eye protection



Wear protective gloves



Wear protective footwear



Wear ear protection



Wear a mask

## 1. SAFETY

### 1.1. ELECTRICAL SAFETY

- WARNING!** It is the user's responsibility to check the following:
- ✓ Check all electrical equipment and appliances to ensure that they are safe before using. Inspect power supply leads, plugs and all electrical connections for wear and damage. Sealey recommend that an RCD (Residual Current Device) is used with all electrical products.
- ✓ If the drilling machine is used in the course of business duties, it must be maintained in a safe condition and routinely PAT (Portable Appliance Test) tested.
- ✓ Electrical safety information, it is important that the following information is read and understood.
- ✓ Ensure that the insulation on all cables and on the appliance is safe before connecting it to the power supply.
- ✓ Regularly inspect power supply cables and plugs for wear or damage and check all connections to ensure that they are secure.
- ✓ Ensure that the voltage rating on the appliance suits the power supply to be used.
- ✗ **DO NOT** pull or carry the appliance by the power cable.
- ✗ **DO NOT** pull the plug from the socket by the cable.
- ✗ **DO NOT** use worn or damaged cables, plugs or connectors. Ensure that any faulty item is repaired or replaced immediately by a qualified electrician.
- ✓ This product should be fitted with a EN 60309 (110volt 16amp) plug.
- ✓ If the cable or plug is damaged during use, switch the electricity supply and remove from use.
- ✓ Replace a damaged plug with a EN 60309 (110volt amp) plug If in doubt contact a qualified electrician.
  - A) Connect the GREEN/YELLOW earth wire to the earth terminal 'E'.
  - B) Connect the BROWN live wire to the live terminal 'L'.
  - C) Connect the BLUE neutral wire to the neutral terminal 'N'.
- ✓ Ensure that the cable outer sheath extends inside the cable restraint and that the restraint is tight.
- ✓ Sealey recommend that repairs are carried out by a qualified electrician.

### 1.2. GENERAL SAFETY

- ✓ Enlist help to place the drill in its working position.
- ✗ **DO NOT** allow non-essential persons, children or animals into the working area. Establish a cordon below.
- ✗ **DO NOT** allow the use of this machine except by those who have received suitable training and have read these instructions.
- ✓ If operating above ground level, use suitable staging to provide a safe working platform.
- ✗ **DO NOT** work from ladders or steps.
- ✓ Use non-original parts; use of such parts may be dangerous will affect the warranty.
- WARNING: Always wear approved eye or face protection when operating this drill. Use a face or dust mask if dust is generated.**
- ✗ **DO NOT** use near flammable gas or liquid, use only in a well lit and ventilated areas.
- ✓ Remove ill fitting clothing, remove ties, watches, rings, and other loose jewellery, and contain long hair.
- ✗ **DO NOT** operate whilst under the influence of drugs, alcohol or intoxicating medication, or if tired.

### 1.3. OPERATIONAL SAFETY

- ✓ **ALWAYS attach** the drill to the work by means of the nylon security strap and buckle, in case of an electrical supply failure releasing the electro-magnet.
- ✓ Ensure that the machine is electrically isolated before installing in its working position and switched off before connecting to supply.
- ✓ Ensure drill is switched off and isolated from mains supply before changing bit, or moving its position.
- ✓ Check that the drill and its electric lead is not damaged before use. **DO NOT** use if any damage is evident.
- ✓ Use non-original parts; use of such parts may be dangerous will affect the warranty.
- ✓ Ensure magnetic switch is in the off position before connecting to mains supply.
- ✓ Only use water as coolant NOT antifreeze.
- ✓ Keep drill dry.
- ✓ If it blows the trip follow these steps: turn off power switch, wait for a few minutes, disconnect from mains.
- ✗ **DO NOT** force the drill by pulling down on the handle with excessive force.
- ✗ **DO NOT** use on non magnetic materials.
- ✗ **DO NOT** use on the same steel work as electric welders are being used.

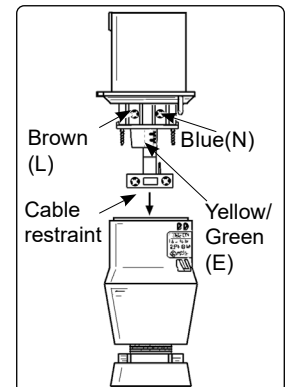

## 2. INTRODUCTION

Manufactured using high quality components for performance and reliability. Lightweight and compact made from heavy duty die cast magnesium alloy. Fitted with a powerful magnet to ensure unit stays adhered at any angle. Includes safety fixing strap, 10mm twist drill chuck and integrated coolant system to extend the life of cutters and increase the quality of the cut. Designed for use in fabrication, construction and other applications when drilling ferrous metal.

## 3. SPECIFICATION

Model No.....	MAG110V
Cable Length.....	2.2m
Magnet Adhesion .....	14000N
Maximum Annular Cutter Capacity.....	35mm
Maximum Cutter Depth .....	50mm
Motor Power.....	1500W
No Load Speed .....	800rpm
Supply .....	110V ~ 50Hz
Consumables (not included)	
Neat Cutting Oil.....	NCO/5L
Soluble Cutting Oil .....	SCO/5L
Pilot Rod .....	RBSP
HSS Magnetic Drill Cutters	
12mm .....	RBHSS12S
13mm .....	RBHSS13S
14mm .....	RBHSS14S
16mm .....	RBHSS16S
18mm .....	RBHSS18S
20mm .....	RBHSS20S
22mm .....	RBHSS22S
24mm .....	RBHSS24S
25mm .....	RBHSS25S

## 4. ASSEMBLY

### 4.1. FIT COOLANT BOTTLE Refer to fig.1

- 4.1.1. Slacken the 2 thumbscrews and slide bottle cage over the thumbscrews. Tighten thumbscrews.
- 4.1.2. Connect coolant pipe to the valve on the drill head, fig.1.
- 4.1.3. Pipe can be released by pushing in the blue valve.)
- 4.1.4. Make sure the coolant tap is closed, fill the bottle with appropriate lubricant.

### 4.2. FIT CUTTING BIT

- 4.2.1. Wind drill head up to maximum height.
- 4.2.2. Wind the two grub screws, fig.2.6, in to secure the cutting bit.

## 5. OPERATION

### IMPORTANT: MAGNETIC BASE TROUBLESHOOTING

If the magnetic base is not working, first check the fuse and if required replace with the spare fuse provided. See fig.2.

- 5.1. Mark the position of the hole to be drilled on the workpiece.

### 5.2. POSITION THE DRILL

- 5.2.1. Connect to the mains supply. Offer drill to workpiece and line up with the previously marked hole.

**WARNING!** Make sure there is nothing between the magnet and the workpiece **BEFORE** turning the magnet on.

**NOTE:** When using drill vertically use the level, fig.2.7.

- 5.2.2. Ensure the drill head is wound back away from the workpiece before turning the magnet on.

### 5.3. ATTACH DRILL TO WORKPIECE

- 5.3.1. Turn the magnet on, fig.2.2. Wind the drill head down to the workpiece and align the cutting head pin.

### 5.4. FIT THE SAFETY STRAP

- 5.4.1. Place the safety strap through the handle of the drill and around the steelwork. Adjust the length of the strap so that if the drill should fall the drill should not be allowed to swing too far and be damaged.

### 5.5. FILL COOLANT BOTTLE

- 5.5.1. Always use the correct cutting oil, refer to Section 3 and refill once it empties. Never use without coolant.

### 5.6. CUTTING THE HOLE

- 5.6.1. Turn on the cooling tank tap, fig.1.
- 5.6.2. Back the cutting head away from the workpiece, turn the drill motor on, fig.2.1. Check the drill sounds and is operating normally.
- 5.6.3. Turn the handle, fig.2.3, anticlockwise to move the cutting bit towards the workpiece.
- 5.6.4. Start feeding slowly, with not too much force, to prevent overloading the drill.
- CAUTION!** Prepare for bursting through the workpiece.
- 5.6.5. If the drill suddenly stops, you must turn off the motor switch immediately.

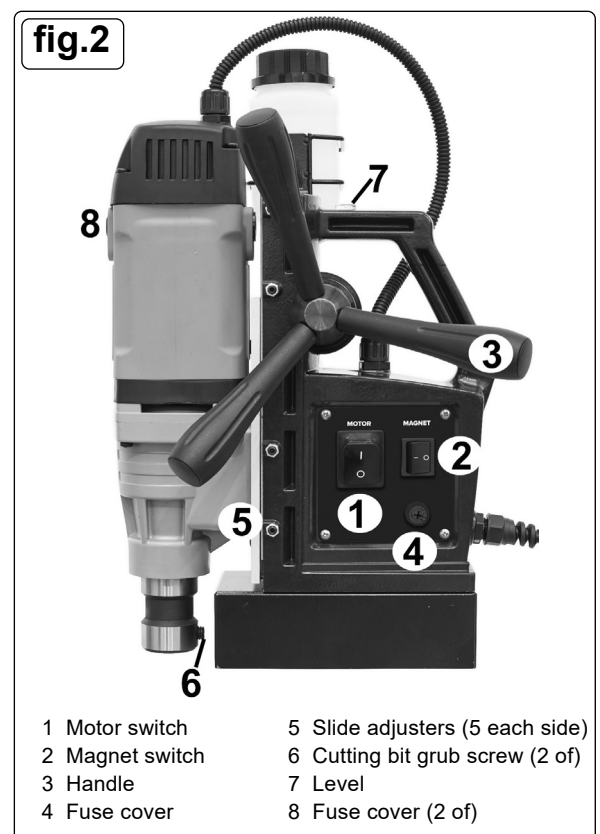
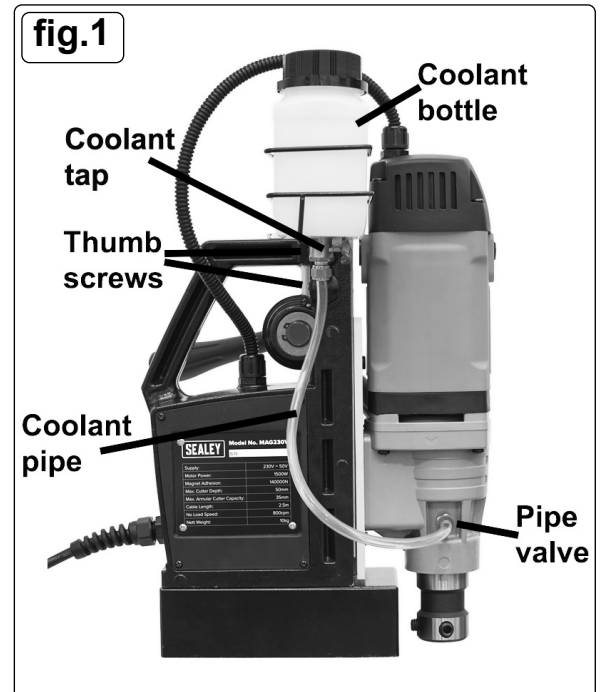

- |                 |                                 |
|-----------------|---------------------------------|
| 1 Motor switch  | 5 Slide adjusters (5 each side) |
| 2 Magnet switch | 6 Cutting bit grub screw (2 of) |
| 3 Handle        | 7 Level                         |
| 4 Fuse cover    | 8 Fuse cover (2 of)             |

- 5.6.6. Once the hole has been cut, back the cutting head back out of the hole and switch off the motor.
- 5.6.7. Turn off the coolant tap.
- 5.6.8. Remove the debris from the cutting head.
- 5.6.9. Clean away swarf.
- 5.6.10. Undo the safety strap.
- 5.6.11. Support the weight of the drill and turn off the magnet. Remove the cutting bit and replace drill in its case.





### 5.7. ADJUSTING THE SLIDES Refer to fig.2.5

❑ **WARNING!** Disconnect from mains supply before performing any adjustments.

- 5.7.1. To adjust the friction on the drill slide mechanism, remove the drill cutter.
- 5.7.2. Loosen the 5 slide locknuts and adjust the 2.5mm grub screws until the required amount of friction on the slides has been achieved.
- 5.7.3. Tighten the locknuts and test before using the drill.

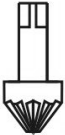
### 5.8. REPLACING THE FUSE Refer to fig.2.4

- 5.8.1. Undo the fuse cover and replace fuse with one of same rating.

				
<b>Core Cutter</b>	<b>Countersunk</b>	<b>Twist Drill</b>	<b>Tapping</b>	<b>Milling cutter</b>
To remove a cylinder of material, much like a hole saw.	To create a cone-shaped depression, to allow a fixing to sit flush with the surface of the material.	To drill holes in a variety of materials.	To cut threads inside a hole.	To cut sideways to widen a hole or taper it off.

## 6. MAINTENANCE

❑ **WARNING!** Disconnect from mains supply before performing any maintenance.

- 6.1. Remove the cut 'plug' from the cutter, each time it is used.
- 6.2. Keep the tool clean.
- 6.3. Store in a dry, childproof location in its case.

## 7. TROUBLESHOOTING

PROBLEM	POSSIBLE CAUSE	SOLUTION
Magnetic base does not function	The contact of the switch is poor.	Check/Repair the switch.
	The power supply is broken.	Check/Repair the power supply.
	The fuse is burned out.	Replace the fuse with appropriate rated fuse.
	The circuit board is burned out.	Replace the circuit board.
	The electromagnet is short-circuited or burned out.	Repair or replace the disk.
	Not adsorbed on the steel frame.	Change the adsorption surface.
The machine does not work after powering up.	The contact of the switch is poor.	Repair/Replace the switch.
	Connectors are loose.	Check the connectors.
	Poor contact between brush and commutator.	Repair or replace the brush.
	The armature or stator coil of the electric drill is burnt out.	Replace the armature or stator.
The magnetic base suction is weak.	The suction workpiece is too thin.	Replace the adsorption surface or thicken the adsorption surface (>10mm steel sheet).
	The adsorption surface is too small.	Replace adsorption surface or temporarily weld thick adsorption surface.
	The support rod is not topped to the suction surface.	The magnetic base suction is weak.
	The diode may be pseudo-soldered.	Reweld the diode.
The guide rail does not run after turning the handle.	The shaft key is broken.	Replace the shaft key.
	The gear and rack are misaligned.	Loosen the screws under the rack and remove the guide plate for repair.
	The pin on the lifting gear is broken.	Replace the pin.
Drill out the elliptical hole.	The fasteners are loosened due to the vibration of the machine.	The fasteners are loosened due to the vibration of the machine.
	Bit unilateral cutting.	Regrind the bit.
	There are impurities on the adsorption surface.	Eliminate impurities.
Hard to shift gears.	The machine must be turned off before changing gears. Turn the spindle with one hand and turn the shift knob with the other.	



#### WEEE REGULATIONS

Dispose of this product at the end of its working life in compliance with the EU Directive on Waste Electrical and Electronic Equipment (WEEE). When the product is no longer required, it must be disposed of in an environmentally protective way. Contact your local solid waste authority for recycling information.



#### ENVIRONMENT PROTECTION

Recycle unwanted materials instead of disposing of them as waste. All tools, accessories and packaging should be sorted, taken to a recycling centre and disposed of in a manner which is compatible with the environment. When the product becomes completely unserviceable and requires disposal, drain any fluids (if applicable) into approved containers and dispose of the product and fluids according to local regulations.



REGISTER YOUR  
PURCHASE HERE

**Note:** It is our policy to continually improve products and as such we reserve the right to alter data, specifications and component parts without prior notice.

**Important:** No Liability is accepted for incorrect use of this product.

**Warranty:** Guarantee is 12 months from purchase date, proof of which is required for any claim.

Sealey Group, Kempson Way, Suffolk Business Park, Bury St Edmunds, Suffolk. IP32 7AR



01284 757500



sales@sealey.co.uk



www.sealey.co.uk